



Features

- For linear measurement along an arc
- Flexible to an 8 inch minimum bend radius arc
- Stroke lengths up to 10 meters
- Proven reliability and ruggedness
- Analog and digital output

Temposonics LF & RF Summary

MTS Temposonics adds flexible sensors to its family of Temposonics magnetostrictive linear position sensors. Based on the principle of magnetostrictive sensing that MTS pioneered, the flexible sensor provides proven non-contact and trouble-free Temposonics performance for very long stroke lengths and linear measurements on an arc.

The new flexible sensors are available with all R Series or L Series outputs including analog outputs, digital pulse outputs, and bus outputs including Profibus and CANbus. Standard stroke lengths for the flexible sensor are up to 9 meters (360 inches) and special applications available by consulting the factory.

Temposonics flexible sensors can be used for linear measurement along an arc such as an index table. The flexible sensors incorporate the MTS Temposonics SE (Sensing Element) technology that is the same building block all Temposonics sensor models use, including R Series and L Series. The flexible sensors are housed in an armored stainless steel housing that is flexible and that can be bent in an arc to an 8 inch minimum bend radius arc. Specifications are measured with flexible sensing element at a 0° degree bend radius. Most operating parameters are identical to its rigid cousin. Linearity performance is $\leq 0.02\%$ of full scale or 0.002" whichever is greater and repeatability is $\leq 0.0001\%$ of full stroke. The operating temperature range is -40°C to +75°C and the environment rating is IP-65.

Temposonics LF: Analog & Digital

The Temposonics LF Series position sensors provide direct analog outputs, including voltage (0 to 10 Vdc, forward or reverse acting) and current (4 to 20 mA or 0 to 20 mA, forward or reverse acting). Both voltage and current outputs allow 5% adjustments of zero and span setpoints. Since the outputs are direct, no signal-conditioning electronics are needed when interfacing with controller or meters.

Other output options are also available with L Series sensors: digital pulse for start/stop or pulse-width modulation (PWM). The Temposonics LF Series position sensors provide direct Start/Stop and pulse-width modulated (PWM) outputs.

Standard resolution is 0.004 inches (when using a 28MHz counter). Higher resolutions are possible with increased circulations.

Since the outputs are direct, no signal-conditioning electronics are needed when interfacing with controllers or meters.

Other output options are also available with LF Series sensors: voltage (0 to 10 Vdc, forward or reverse acting) and current (4 to 20 mA or 0 to 20 mA, forward or reverse acting).

PARAMETER	SPECIFICATION
Measured Variable:	Displacement
Resolution:	Analog: Infinite Digital: 1÷ [gradient x crystal freq. (mHz) x circulation]
Non-Linearity:	± 0.02% or ± 0.05 mm (± 0.002 in.), whichever is greater 0.002 in. is the minimum absolute linearity and varies with sensor model
Outputs:	Analog: Voltage or Current Digital: Start/Stop or PWM

PARAMETER	SPECIFICATION
Measuring Range:	Analog: 250 mm to 2000 mm (10 to 78 in.) Digital: 250 to 7600 mm (10 to 300 in.)
Operating Voltage:	+ 13.5 to 26.4 Vdc (± 0 %): Strokes ≤ 1525 mm (60 in.) + 24 Vdc (± 10 %): Strokes > 1525 mm (60 in.)
Power Consumption:	100 mA
Adjustment of Zero & Span:	Field adjustable zero and span to 5% of active stroke (for Analog sensors only)
Update Time:	Analog: ≤ 1 ms Digital: Minimum = [Stroke (specified in inches) + 3] x 9.1

Temposonics RF: Analog & SSI

The “smart” R Series position sensors provide fast, reliable, and highly precise data processing and communication. R Series sensors offer modular construction and non-contacting magnetostrictive technology. Displacement and velocity data is preprocessed by the sensor electronics, thereby reducing the processing overhead of your machine controller.

Dual, simultaneous analog outputs are offered as standard (i.e., one displacement and

one velocity output using one magnet, or two identical displacement outputs using two magnets). Like all of our sensors, the Temposonics III sensors are non-contacting magnetostrictive technology.

R Series position sensors provide direct analog outputs, including voltage and current. Both voltage and current outputs allow 100% adjustments of zero and span setpoints. Since the outputs are direct, no signal-conditioning electronics are needed when interfacing with controllers or meters.

R Series position sensors are available with a widely accepted controller interface: Serial Synchronous Interface (SSI). Position data from the sensors encoded in a 24 to 25 bit binary or Grey Code format and transmitted at very high speed via a synchronous interface.

SSI output provides effective synchronization in a closed-loop control system. A clock pulse train from a controller is used to gate out sensor data: one bit at a time.

Analog

PARAMETER	SPECIFICATION
Measured Variable:	Displacement, Velocity (magnitude only)
Resolution:	16 bit or 0.025 mm, whichever is greater
Non-Linearity:	< ± 0.02% of full stroke or ± 0.05 mm, whichever is greater
Output:	Voltage: 0 to 10 Vdc or +10 to 0 Vdc; Minimum load: ≥ 5 kΩ * Current: 4 (0) to 20 mA, 20 to 4 (0) mA; Maximum load: ≤ 500Ω
Measuring Range:	250 mm to 10,060 mm (10 to 396 in.)
Operating Voltage:	+ 24 Vdc (+ 20%, 15 %)
Power Consumption:	100 mA typical
Velocity:	Velocity output range: 0.1 to 10 m/s or 1.0 to 400.0 in./s Minimum velocity: 1.0 in./s or 0.05 x stroke; length in inches, whichever is less (factory calibrated)
Adjustment of Zero & Span:	100% field adjustment of measuring range
Update Time:	≤ 1 ms typical (length dependent)
Sealing:	IP 65

SSI

PARAMETER	SPECIFICATION
Resolution:	Up to 0.002 mm
Non-Linearity:	< ± 0.01% of full stroke or ± 0.04 mm, whichever is greater*
Data Format:	Serial Synchronous Interface (SSI): Binary or Gray code
Maximum Data Length:	24 or 25 bit
Measuring Range:	250 mm to 10,060 mm (10 to 396 in.) <i>The resolution may be limited by stroke length.</i>
Sealing:	IP 65

* Due to single ended power supply, 0.0 V is not attainable. Typical minimum voltage is 50 mV. Specifications are subject to change without notice.

Temposonics RF: BUS

CANbus

DeviceNet/ CANbus provides precise, fast, and reliable data processing for high-speed control in industrial automation applications, multi-tasking capabilities, simplified bus wiring, sensor-based diagnostics, and easy expendability.

About CANbus

DeviceNet is a CANbus (Controller Area Network) network that links all system components via an open fieldbus system. CANbus allows you to interface up to or from 64 to 125 devices using a single cable, thus eliminating the need for conventional methods of multiple wire runs. CANbus offers a cost-effective communication link from industrial measurement and control devices to a network.

CANbus provides a way to define how, and in which priority, data will be transmitted over a network. Together, the open CANbus protocol and the MTS “smart” Temposonics III sensors offer an effective, high-precision data transfer system that is well suited for industrial automation.

Plug and Play

Plug and play makes installation quick and easy. After initial system configuration, the user is not required to have extensive knowledge concerning network timing and sensor technology.

DeviceNet

About DeviceNet

DeviceNet is a CAN-based (Controller Area Network) network that links all system components via an open databus system. DeviceNet allows you to interface up to 64 devices using a single cable, thus eliminating the need for conventional methods of multiple wire runs. DeviceNet offers a cost-effective communication link from industrial measurement and control devices to a network.

DeviceNet provides a way to define how, and in which priority, data will be transmitted over a network. Together, the open DeviceNet protocol and the MTS “smart” Temposonics III sensors offer an effective, high-precision data transfer system that is well suited for industrial automation.

Plug and Play

Plug and play makes installation quick and easy. After initial system configuration, the user is not required to have extensive knowledge concerning network timing and sensor technology.

Each sensor is provided with an Electronic Data Sheet (EDS) on a 3 1/2 inch floppy disk. Sensor-specific parameters are installed into the network using the EDS file. A PC programming tool, such as DeviceNet Manager offered by Allen Bradley, is used to set the node identifier and baud rate (node identifier is factory set at node 63 and baud rate is factory set at 500 kBit/sec.).

Temposonics III sensors with DeviceNet output can be directly connected to a DeviceNet network. The sensor acts as a “slave” device which transmits its position and status data upon request to the “master” device such as a PLC or IPC.

CANbus

PARAMETER	SPECIFICATION
Resolution:	Up to 0.002 mm
Non-Linearity:	< ± 0.01% of full stroke or ± 0.04 mm, whichever is greater
Output Signal:	CANbus
Data Protocol:	MTS protocol
Baud Rate:	1 Mbit/sec. maximum
Measuring Range:	250 mm to 10,060 mm (10 to 396 in.)
Operating Voltage:	+ 24 Vdc (+20%, 15 %)
Power Consumption:	100 mA typical
Sealing:	IP 65

DeviceNet

PARAMETER	SPECIFICATION
Resolution:	Up to 0.002 mm
Non-Linearity:	< ± 0.01% of full stroke or ± 0.04 mm, whichever is greater
Output Signal:	CAN-Field-bus System ISO 11898
Data Protocol:	DeviceNet/CANbus
Baud Rate:	Up to 500 kbit/sec.
Measuring Range:	250 to 4800 mm (10 to 188 in.)
Operating Voltage:	+ 24 Vdc (+20%, 15 %)
Power Consumption:	100 mA typical
Sealing:	IP 65

Note: EDS for DeviceNet and CAN-Open and the GSD for Profibus are available on the MTS website at www.temposonics.com.

T e m p o s o n i c s R F : B U S

Profibus

Profibus is a vendor-independent, open fieldbus standard (EN 50 170). The DP (Decentralized Periphery) bus version is designed for high-speed data communication at the machine level. Here, the central controller (Master) will communicate with the distributed, intelligent field devices (Slaves) via a high-speed serial link. Most of the data transfer is done and monitored on master and slave side. In addition to cyclic user data transmission, PROFIBUS-DP provides powerful functions for diagnostics and configuration. For installation all characteristic sensor parameters are loaded into the bus via the configuration tool on disc, the GSD file.

PROFIBUS-DP represents the optimum combination of

- **High data throughput**
- **Simple installation and service**
- **Diagnostics capabilities**
- **Error-free proven transmission technology**

PROFIBUS technology is developed and administrated by the PROFIBUS User Organization (PNO).

Profibus

PARAMETER	SPECIFICATION
Measured Variable:	Displacement
Resolution:	20 µm Standard
Non-Linearity:	< ± 0.01 % F.S. (Minimum ± 50 µm)*
Output:	PROFIBUS-DP System according ISO 74498
Data Protocol:	PROFIBUS-DP (EN 50 170)
Measuring Range:	250 mm to 8385 mm (10 to 330 in.)
Operating Voltage:	+ 24 Vdc (+20%, 15 %)
Power Consumption:	100 mA typical
Baud Rate:	Supports up to 12 Mbit/ Sec. Cable specifications per EN 50170 Cable length dependent
Sealing:	IP 65

Note: EDS for DeviceNet and CAN-Open and the GSD for Profibus are available on the MTS website at www.temposonics.com. Additional technical information is also available for the Profibus on our website.

**L Series Flex Style
Model Type LF**

Stroke-Dependent Dead Zones (LF Model)	
Stroke Length 254-7620 mm (10-300 in.)	Dead Zones 94 mm (3.7 in.)

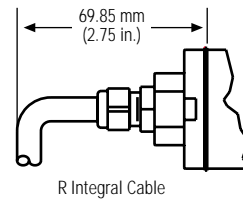
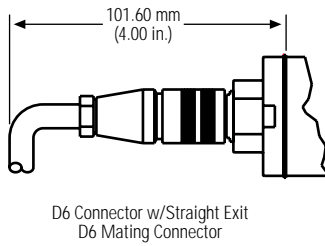
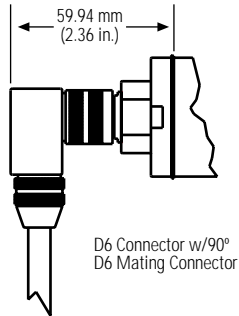
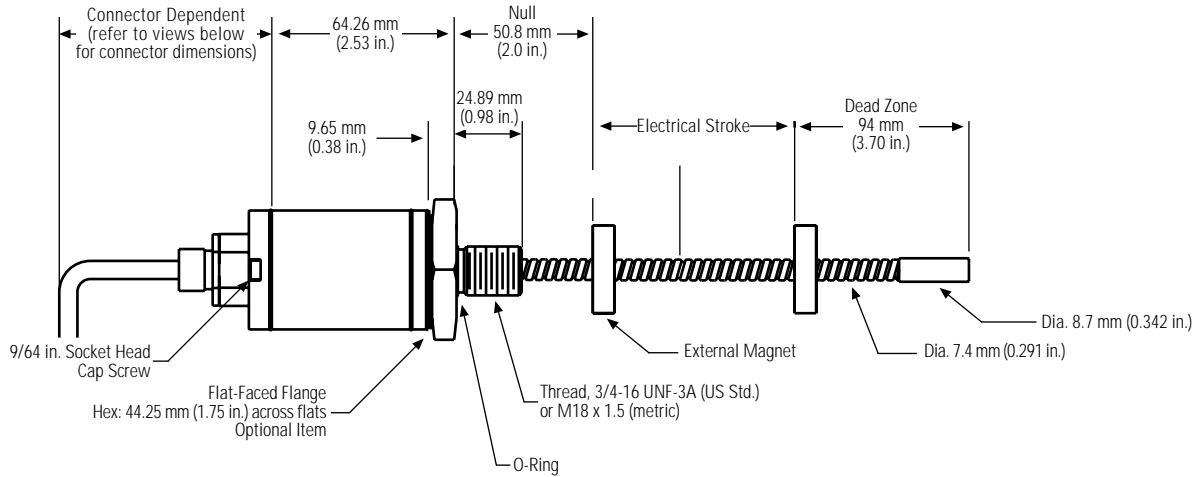

**Temposonics III RF Flex Style
Model Style RF Analog/SSI**

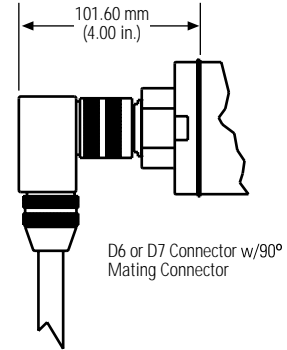
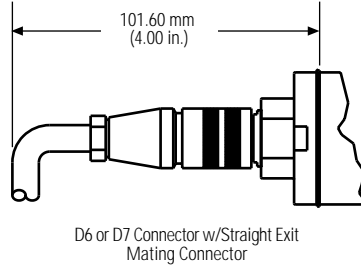
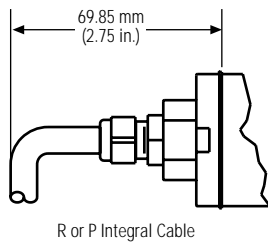
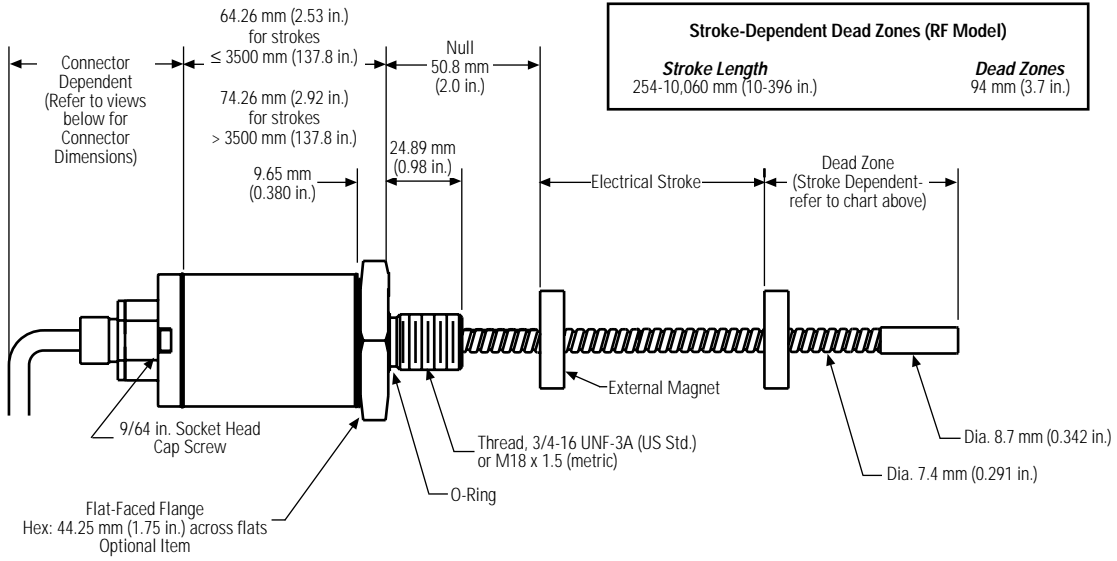

R Series RF Flex Series CANbus/Profibus

- CANbus and Profibus utilizes Dual 6-pin DIN Connector

Stroke-Dependent Dead Zones (RF Model)	
Stroke Length	Dead Zones
CANbus 254-10,060 mm (10-396 in.)	94 mm (3.7 in.)
Profibus 254-8380 mm (10-330 in.)	94 mm (3.7 in.)

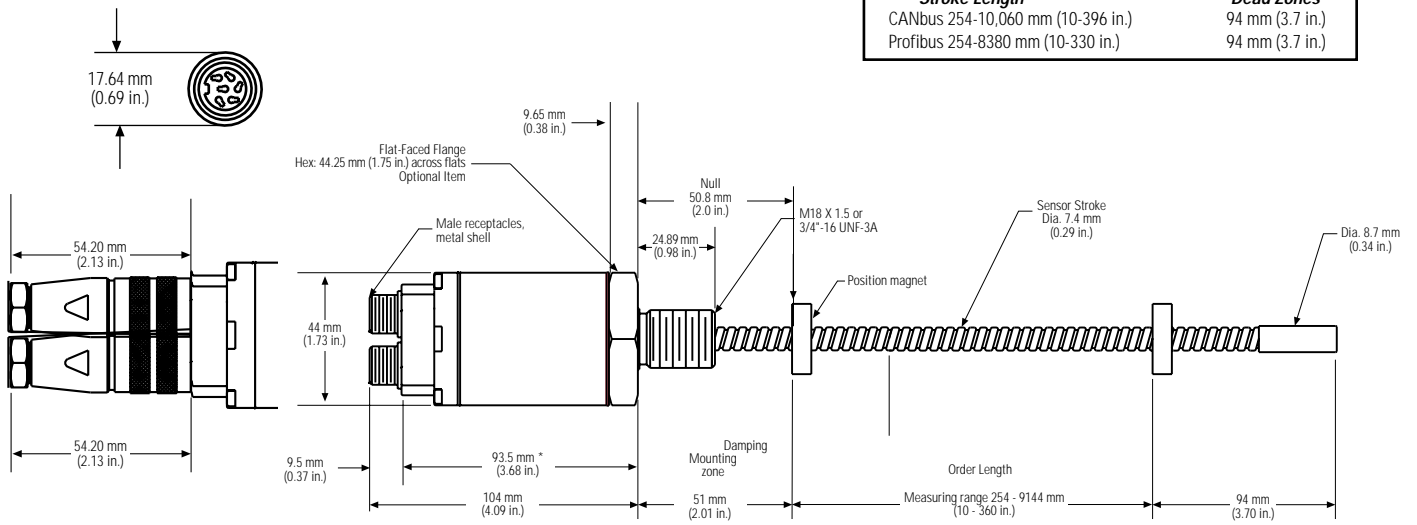

*** NOTE:**
 For CANbus Sensors with stroke \leq 137.8 in. (3500mm) this dimension will be 83.57 mm (3.29 in.).

R Series RF Flex Series DeviceNet

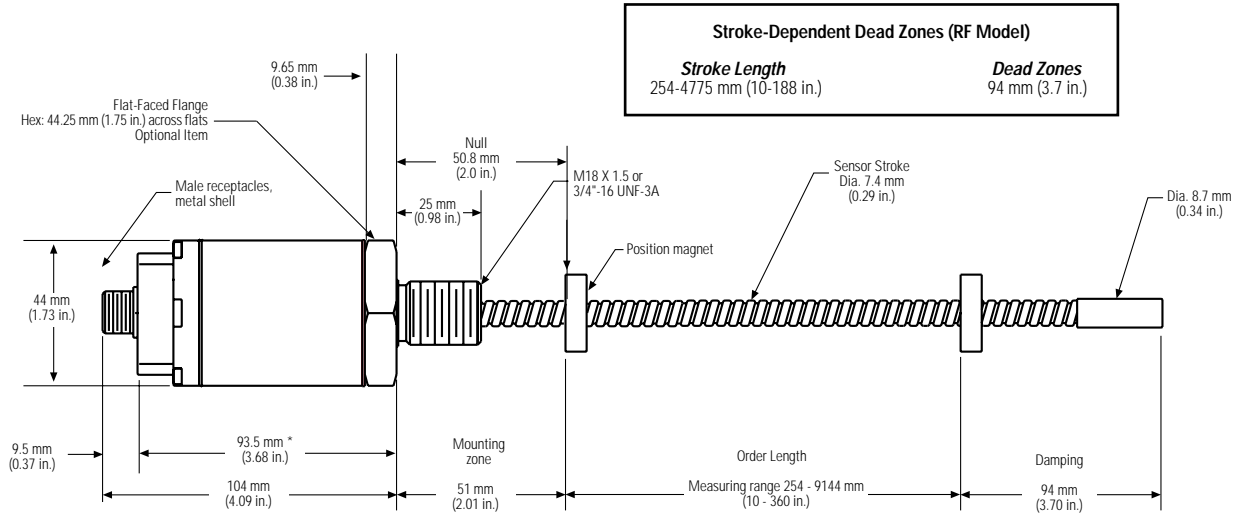

Stroke-Dependent Dead Zones (RF Model)	
Stroke Length	Dead Zones
254-4775 mm (10-188 in.)	94 mm (3.7 in.)

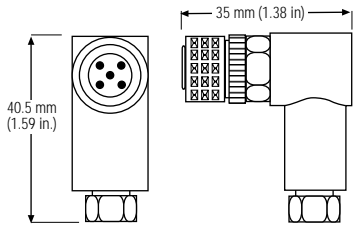

MTS P/N 370376
90° Micro Mating Field-Installable connector

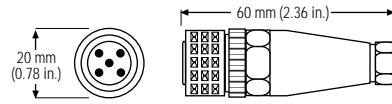

MTS P/N 370375
Straight Exit Micro Mating Field-Installable connector

*** NOTE:**
 For strokes \leq 3500 mm (137.8 in.) this dimension is 83.57 mm (3.29 in.).
 For strokes $>$ 3500 mm (137.8 in.) this dimension is 93.47 mm (3.68 in.).

Tempsonics LF

INTEGRAL CABLE:

(Start/Stop or PWM)

Wire Color	Function
Gray	(-) Gate for PWM, (-) Stop for Start/Stop
Pink	(+) Gate for PWM, (+) Stop for Start/Stop
Yellow	(+) Interrogation for PWM, (+) Start for Start/Stop
Green	(-) Interrogation for PWM, (-) Start for Start/Stop
Red or Brown	Customer Supplied Power (+ Vdc)*
White	DC Ground

INTEGRAL D6 CONNECTOR PWM OR START/STOP:

Pin No. Wire Color Function

Pin No.	Wire Color	Function
1	Gray	(-) Gate for PWM, (-) Stop for Start/Stop
2	Pink	(+) Gate for PWM, (+) Stop for Start/Stop
3	Yellow	(+) Interrogation for PWM, (+) Start for Start/Stop
4	Green	(-) Interrogation for PWM, (-) Stop for Start/Stop
5	Red or Brown	Customer Supplied Power (+ Vdc)*
6	White	DC Ground

Sensor End View

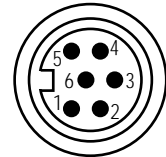

Pin outs for
6-Pin D6 90° and
Straight-exit Connector

* Power requirements are stroke length dependent.
+ 13.5 to 26.4 Vdc (± 0%): Stroke lengths ≤ 1525 mm (60 in.)
+ 24 Vdc (± 10%): Stroke lengths > 1525 mm (60 in.)

INTEGRAL CABLE:

Analog Output: (Voltage or Current)

Wire Color	Function
Gray	0 to 10 Vdc, 4 to 20 mA, 0 to 20 mA
Pink	Displacement Output Return for Gray Wire
Yellow	10 to 0 Vdc, 20 to 4 mA, or 20 to 0 Vdc
Green	Displacement Output Return for Yellow Wire
Red or Brown	Customer Supplied Power (+ Vdc)*
White	DC Ground

INTEGRAL D6 CONNECTOR ANALOG:

Pin No. Wire Color Function

Pin No.	Wire Color	Function
1	Gray	0 to 10 Vdc, 4 to 20 mA, 0 to 20 mA
2	Pink	Return for Pin 1
3	Yellow	10 to 0 Vdc, 20 to 4 mA, or 20 to 0 mA
4	Green	Return for Pin 3
5	Red or Brown	Customer Supplied Power (+ Vdc)*
6	White	DC Ground

Sensor End View

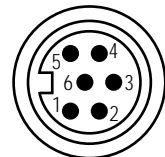

Pin outs for
6-Pin D6 90° and
Straight-exit Connector

* Power requirements are stroke length dependent.
+ 13.5 to 26.4 Vdc (± 0%): Stroke lengths ≤ 1525 mm (60 in.)
+ 24 Vdc (± 10%): Stroke lengths > 1525 mm (60 in.)

Tempsonics RF

INTEGRAL DUAL 6-PIN CONNECTOR PROFIBUS:

Pin	Wire Color	Function
1	Green	RxD / TxD-N (Bus)
2	Red	RxD / TxD-P (Bus)
3	----	DGND (female receptacle only, for bus termination)
4	----	VP (female receptacle only, for bus termination)
5	Black	+ 24 Vdc
6	Yellow/Green	Shielding, machine ground

INTEGRAL DUAL 6-PIN CONNECTOR CANBUS:

Pin	Wire Color	Function
1	Gray	CAN (-)
2	Pink	CAN (+)
3	Not used	
4	Not used	
5	Brown	+24 Vdc (+20%/-15%)
6	White	DC Ground
7	Not used	

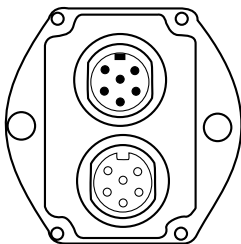

1 x 6-pin DIN male receptacle
1 x 6-pin DIN female receptacle

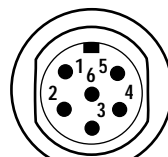

External View
Pin outs for
6-Pin D6 90° and
Straight-exit Connector

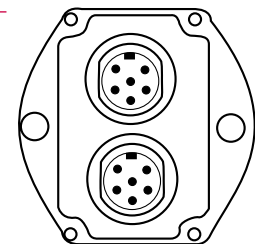

Dual 6 pin DIN male receptacle

Temposonics RF (Con't)

DEVICENET OUTPUT

INTEGRAL 5-PIN CONNECTOR:

Pin No.	Function
1	Shield
2	+ 24 Vdc (customer provided)
3	DC Ground
4	CAN-H (dominant high)
5	CAN-L (dominant low)

* Molded extension cables are also available from a third party vendor.

Contact MIS for more information

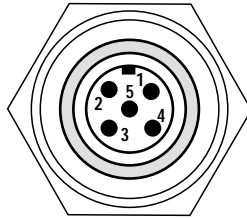

Exploded View of Integral Micro Connector with Pin Identification (External View)

SSI OUTPUT

INTEGRAL CABLE SSI:

Wire Color	Function
Gray	(-) Data
Pink	(+) Data
Yellow	(+) Clock
Green	(-) Clock
Red or Brown	+ 24 Vdc, Customer Supplied
White	DC Ground
Blue	No Connection

INTEGRAL D7 CONNECTOR:

Pin No.	Wire Color	Function
1	Gray	Data (-)
2	Pink	Data (+)
3	Yellow	Clock (+)
4	Green	Clock (-)
5	Brown	+ 24 V dc
6	White	DC Ground

* Power requirements are stroke length dependent.
 + 13.5 to 26.4 Vdc ($\pm 0\%$): Stroke lengths ≤ 1525 mm (60 in.)
 + 24 Vdc ($\pm 10\%$): Stroke lengths > 1525 mm (60 in.)

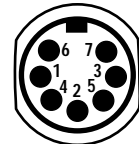

External View Sensor Male Receptacle
 Pin outs for 7-Pin D6 90° and Straight-exit Connector

ANALOG OUTPUT

INTEGRAL CABLE:

Wire Color	Function
Gray	Output #1 (Displacement) * 0 to 10 Vdc, 10 to 0 Vdc 4 to 20 mA, 20 to 4 mA, 0 to 20 mA or 20 to 0 mA
Pink	Displacement Output Return for Gray Wire
Yellow	Output #2 (Displacement or Velocity) * 0 to 10 Vdc, 10 to 0 Vdc 4 to 20 mA, 20 to 4 mA, 0 to 20 mA or 20 to 0 mA
Green	Displacement Output Return for Yellow Wire
Red or Brown	+ 24 Vdc (+20%, -15%), Customer Supplied
White	DC Ground

* When using dual outputs, outputs #1 and #2 must have the same output scale (i.e., voltage or current) and the same orientation (i.e., forward or reverse acting).

INTEGRAL D6 CONNECTOR:

Pin No.	Wire Color	Function
1	Gray	Output 1: Position 0 - 10 V 4 - 20 mA / 20 - 4 mA 0 - 20 mA / 20 - 0 mA
2	Pink	DC Ground
3	Yellow	Output 2: Position or Velocity 0 - 10 V / 10 - 0 V 4 - 20 mA / 20 - 4 mA 0 - 20 mA / 20 - mA
4	Green	DC Ground
5	Brown	+ 24 Vdc (-15%/+20%)
6	White	DC Ground (OV)

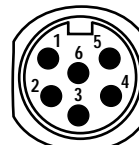

Sensor Male Receptacle (External View)

CAUTION!

When wiring Temposonics III sensors, **DO NOT** connect DC ground to the cable shield or drain wire.

L SERIES: "LF" FLEXIBLE SENSOR

2-4 Digit code
depending on
output selected

When placing an order, build the desired model number using the model number guide (right). A wide range of L Series sensor configurations are available to meet the demands of your particular application. See the following page for how to order extension cables and accessories.

If you have any questions about how to apply L Series position sensors, please contact one of our Application Engineers or your local MTS distributor—they are available to help you design an effective position sensing system to fit your application.

POSITION SENSORS

L	F																		
---	---	--	--	--	--	--	--	--	--	--	--	--	--	--	--	--	--	--	--

HEX STYLE _____

S = Standard US customary threads, flat faced hex (pressure pipe not included)
M = Metric threads, flat faced hex (pressure pipe not included)

CONNECTION TYPE _____

D6 = 6 pin DIN connector
RO = Integral cable with pigtail

INTEGRAL CABLE LENGTH _____

00 = No integral cable (i.e., sensor with integral connectors)
02 = 2 meter integral cable; standard with metric stroke lengths (i.e., millimeters)
05 = 5 ft. integral cable; standard with US stroke lengths (i.e., inches and tenths)
01 - 99 = Custom cable length 1 to 99 ft. (or 1 to 30 m)
 (Encode length in feet if using US customary stroke length, in meters if using metric stroke length)

UNIT OF MEASURE _____

U = US customary (inches)
M = Metric (millimeters)

LENGTH _____

_____ Inches and tenths (1 to 300 in. in 0.5 in. increments)
 _____ Millimeters (25 to 7625 mm in 5 mm increments)

INPUT VOLTAGE _____

2 = +24 Vdc

DIGITAL OUTPUT (available up to 300 in.)

RO = Start/Stop
D _____ = pulse-width modulated output followed by E or I for external or internal interrogation then by the # of recirculations (15 max. See Table A and B).

ANALOG OUTPUT

VO = 0-10 Vdc and 10 - 0 Vdc (Available to 78 in.)
AO = 4 to 20 mA (Available to 100 in.)
A1 = 20 to 4 mA (Available to 100 in.)
A2 = 0 to 20 mA (Available to 100 in.)
A3 = 20 to 0 mA (Available to 100 in.)

Table A

Circulation Count vs. Resolution for PWM Output (Based on 28 MHz counter)

Resolution	Circulation Count*
0.00026	15
0.0005	8
0.001	4
0.002	2
0.004	1

* Maximum circulation count is limited by stroke length for sensors configured for internal interrogation. (Refer to Table B for stroke length limitations.)

Table B

Maximum Stroke per Circulation Count for PWM Output w/Internal Interrogation

Maximum Stroke	Circulation Count
≤ 84 inches	15
> 84.1 inches	1

R SERIES: "RF" FLEXIBLE SENSOR ANALOG OUTPUT

1-7 digit code depending on output selected

POSITION SENSORS

HEX STYLE
S = English threads, flat faced (pressure pipe not included)
M = Metric threads, flat faced hex (pressure pipe not included)

STROKE LENGTH
 - - - - - Inches and tenths (available up to 396 in. in 0.5 in. increments)
 - - - - - Millimeters (available up to 10,060 mm in 5 mm increments)
 * consult factory for longer lengths

UNIT OF MEASURE
U = US customary (inches)
M = Metric (millimeters)

CONNECTION TYPE
D60 = Integral 6-pin DIN connector
R - - - = Integral cable length 1 to 99 ft. (1 to 30 m)
 Encode in feet if using Unit of Measure in inches
 Encode in meters if using Unit of Measure in millimeters

INPUT VOLTAGE
1 = +24 Vdc (+20%, -15%)

ANALOG OUTPUT
 Single magnet with displacement only

VO - - - - - = 0 to 10 Vdc **AO** - - - - - = 4 to 20 mA **A2** - - - - - = 0 to 20 mA
V1 - - - - - = -10 to 0 Vdc **A1** - - - - - = 20 to 4 mA **A3** - - - - - = 20 to 0 mA

When placing an order, build the desired model number using the model number guide (right). A wide range of R Series sensor configurations are available to meet the demands of your particular application. See the following page for how to order extension cables and accessories.

If you have any questions about how to apply R Series position sensors, please contact one of our Application Engineers or your local MTS distributor—they are available to help you design an effective position sensing system to fit your application.

1 = One (1) displacement output only
 To complete the analog output code, select from the 1 to 5 digit option codes below.

Single Magnet Analog System
1 = One (1) displacement output only
2 - - - - - = One (1) each displacement and velocity (magnitude only) output
 (fill in blanks with desired max. velocity) **See chart at right.**

Velocity output range: 001.0 in. to 400.0 in./second or meter equivalents
Minimum velocity: 1.0 in./second or 0.05 x stroke length in inches, whichever is greater.
Maximum velocity: 400 in./second or 100 x stroke length in inches, whichever is less.

Dual Magnet Analog System
2 = Two (2) displacement outputs (Set points are referenced to the zero point of each application housing.)

NOTE:
 Custom analog setpoints available. Contact application Engineering for details.

Output	Velocity Output - Magnet Position:			
	Velocity Direction			
	Head	Magnet at rest	Tip	
0 - 10 Vdc	10	- 0	-	10
10 - 0 Vdc	10	- 0	-	10
4 - 20 mA	20	- 4	-	20
20 - 4 mA	20	- 4	-	20
0 - 20 mA	20	- 0	-	20
20 - 0 mA	20	- 0	-	20

CUSTOM PRODUCT

R SERIES: "RF" FLEXIBLE SENSOR CANBUS OUTPUT

When placing an order, build the desired model number using the model number guide (right). A wide range of R Series sensor configurations are available to meet the demands of your particular application. See the following page for how to order extension cables and accessories.

If you have any questions about how to apply R Series position sensors, please contact one of our Application Engineers or your local MTS distributor—they are available to help you design an effective position sensing system to fit your application.

POSITION SENSORS R F

1-7 digit code depending on output selected

HEX STYLE

S = English threads, flat faced (pressure pipe not included)
M = Metric threads, flat faced hex (pressure pipe not included)

STROKE LENGTH

---.--- inches and tenths (available up to 396 in. in 0.5 in. increments)
---.--- millimeters (available up to 10,060 mm in 5 mm increments)

UNIT OF MEASURE

U = US customary (inches)
M = Metric (millimeters)

CONNECTION TYPE

D62 = Integral dual 6-pin DIN male connectors

INPUT VOLTAGE

1 = +24 Vdc, (+20%, -15%)

OUTPUT

C ---.---.---.---.---.--- = CANbus Output (Fill in the six blanks with the following codes)
a b c d e f

a) HARDWARE

1 = MTS Protocol (Single Magnet)
2 = MTS Protocol (Multi-Magnet)

b) CANBUS PROTOCOL CODE

01 = Single Magnet
07 = Multi-magnet *

c) BAUD RATE

1 = 1000 Kbits/s
2 = 500 Kbits/s
3 = 250 Kbits/s
4 = 125 Kbits/s

d) RESOLUTION

1 = 0.005 mm
2 = 0.002 mm

e,f) CYCLE TIME

1 = Standard

* Specify the number of magnets utilized at the time of order.

R SERIES: "RF" FLEXIBLE SENSOR DEVICENET OUTPUT

POSITION SENSORS R F

1-7 digit code depending on output selected

HEX STYLE

S = English threads, flat faced (pressure pipe not included)
M = Metric threads, flat faced hex (pressure pipe not included)

STROKE LENGTH

---.--- inches and tenths (available up to 188 in. in 0.5 in. increments)
---.--- millimeters (available up to 4775 mm in 5 mm increments)

UNIT OF MEASURE

U = US customary (inches)
M = Metric (millimeters)

CONNECTION TYPE

D51 = Integral 5-pin DIN Micro connector

INPUT VOLTAGE

1 = +24 Vdc, (+20%, -15%)

OUTPUT

C ---.---.---.---.---.--- = DeviceNet Output (Fill in the six blanks with the following codes)
a b c d e f

a) HARDWARE

2 = Standard

b,c) PROTOCOL

02 = DeviceNet

d) BAUD RATE

2 = 500 Kbits/s
3 = 250 Kbits/s
4 = 125 Kbits/s

e) RESOLUTION

1 = 0.005 mm
2 = 0.002 mm

f) CYCLE TIME

1 = Standard

CUSTOM PRODUCT

TEMPOSONICS III: "RF" FLEXIBLE SENSOR PROFIBUS OUTPUT

1-4 digit code depending on output selected

When placing an order, build the desired model number using the model number guide (right). A wide range of R Series sensor configurations are available to meet the demands of your particular application. See the following page for how to order extension cables and accessories.

If you have any questions about how to apply R Series position sensors, please contact one of our Application Engineers or your local MTS distributor—they are available to help you design an effective position sensing system to fit your application.

POSITION SENSORS

R F

HEX STYLE
S = English threads, flat faced (pressure pipe not included)
M = Metric threads, flat faced hex (pressure pipe not included)

STROKE LENGTH
 _____ inches and tenths (available up to 330 in. in 0.5 in. increments)
 _____ millimeters (available up to 8380 mm in 5 mm increments)

UNIT OF MEASURE
U = US customary (inches)
M = Metric (millimeters)

CONNECTION TYPE
D63 = Dual 6 pin DIN male and female connectors

INPUT VOLTAGE
1 = +24 Vdc, (+20%, -15%)

PROFIBUS OUTPUT

P _____
 a b c

a) HARDWARE
2 = Standard

b,c) SOFTWARE
01 = multi-magnet (Specify number of magnets utilized at time of order)
02 = single magnet

R SERIES: "RF" FLEXIBLE SENSOR SSI OUTPUT

1-7 digit code depending on output selected

POSITION SENSORS

R	F																				
---	---	--	--	--	--	--	--	--	--	--	--	--	--	--	--	--	--	--	--	--	--

When placing an order, build the desired model number using the model number guide (right). A wide range of R Series sensor configurations are available to meet the demands of your particular application. See the next page for how to order extension cables and accessories.

If you have any questions about how to apply MTS R Series position sensors, please contact one of our Application Engineers or your local MTS distributor—they are available to help you design an effective position sensing system to fit your application.

HEX STYLE _____
S = English threads, flat faced (pressure pipe not included)
M = Metric threads, flat faced hex (pressure pipe not included)

STROKE LENGTH _____
 - - - - inches and tenths (available up to 396 in. 0.5 in. increments)
 - - - - millimeters (available up to 10,060mm in 5 mm increments)

UNIT OF MEASURE _____
U = US customary (inches)
M = Metric (millimeters)

CONNECTION TYPE _____
 Connector
D70 = Integral 7-pin DIN connector
 Integral Cable
P - - - - = Encode in feet if using US customary stroke length, encode in meters if using metric stroke length
 Range: 1 (01) to 99 (99) ft. or 1 (01) to 30 (30) meters

INPUT VOLTAGE _____
1 = +24 Vdc, (+20%, -15%)

OUTPUT _____
C - - - - - = DeviceNet Output (Fill in the six blanks with the following codes)
 a b c d e f

a) DATA LENGTH
1 = 25 Bits
2 = 24 Bits

b) OUTPUT FORMAT
B = Binary
G = Gray Code

c) RESOLUTION
1 = 0.005 mm
2 = 0.01 mm
3 = 0.05 mm
4 = 0.1 mm
5 = 0.02 mm
6 = 0.002 mm*

d) PERFORMANCE
1 = Standard

e,f) SCALE ORIENTATION
00 = Forward-acting
01 = Reverse-acting
02 = Forward-acting Synchronized

* Stroke limited to 766 mm

Part No. 401468 *

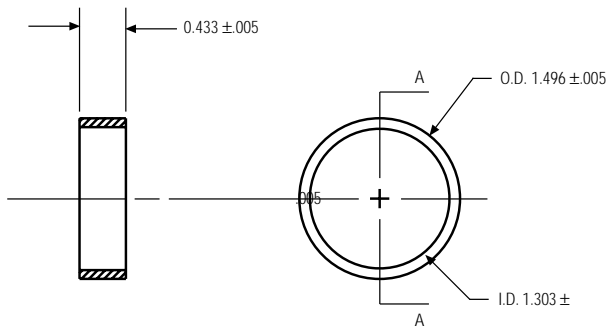

Part No. 401467 *

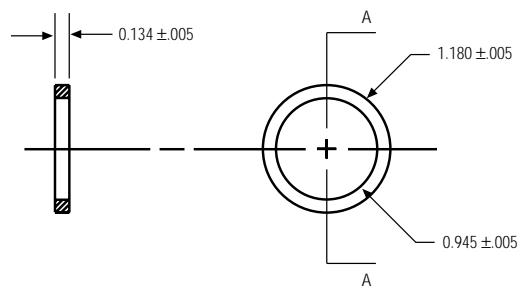

*** NOTE:**

The above magnets, Part No. 401468 and Part No. 401467, are made of nonferrous material and must be inserted into an appropriate carrier/holder.

Part No. 201554

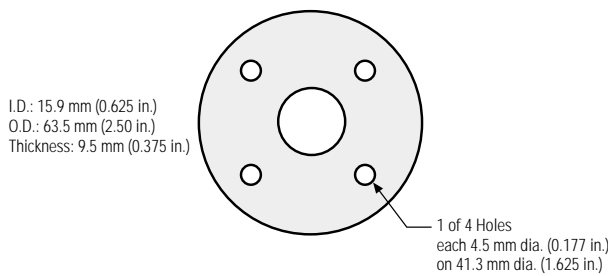

Part No. 201553

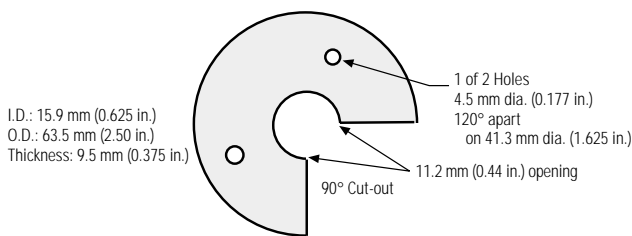

Part No. 251298-2 †

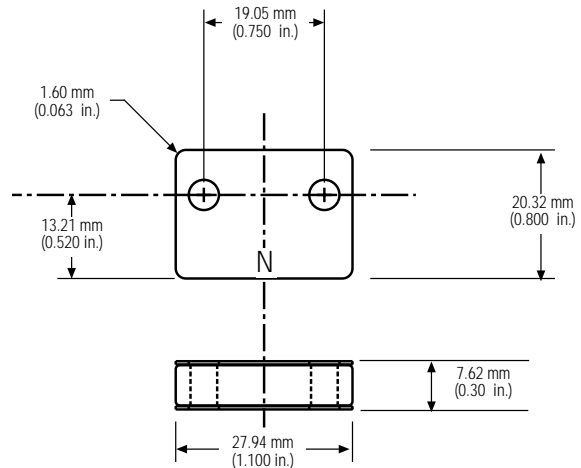

† NOTE:

For the above magnet, Part No. 251298-2:
 1) For use on Sensors 300 Inches or less
 2) Magnet must be kept within 3mm (+/- 2) mm

Part No. 400633

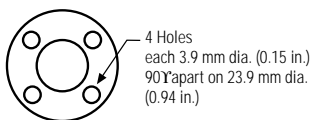

Magnet Spacer
 ID: 14.3 mm (0.563 in.)
 OD: 31.75 mm (1.25 in.)
 Thickness: 3.175 mm (0.125 in.)

Part No. 201542

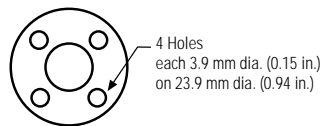

ID: 13.5 mm (0.53 in.)
 OD: 32.8 mm (1.29 in.)
 Thickness: 7.9 mm (0.312 in.)

Part No. 251416

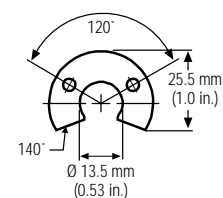

Consult application engineering when using multiple magnets.

EXTENSION CABLES TEMPOSONICS LF AND RF (RF OUTPUTS - ANALOG ONLY)

When placing an order, build the desired model number using the model number guide (right). A wide range of R Series sensor configurations are available to meet the demands of your particular application.

If you have any questions about how to apply R Series position sensors, please contact one of our Application Engineers or your local MTS distributor—they are available to help you design an effective position sensing system to fit your application.

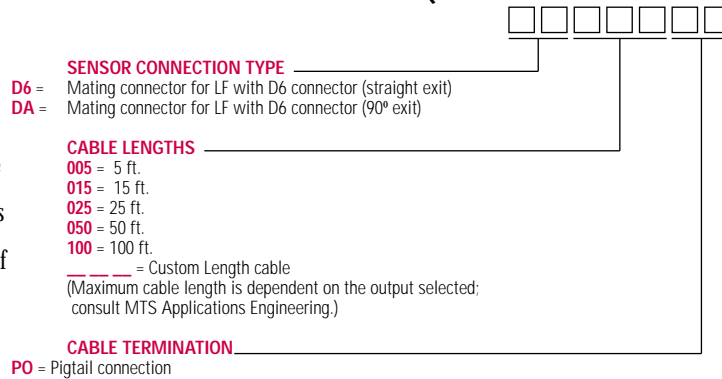

EXTENSION CABLES TEMPOSONICS RF (RF OUTPUTS - SSI ONLY)

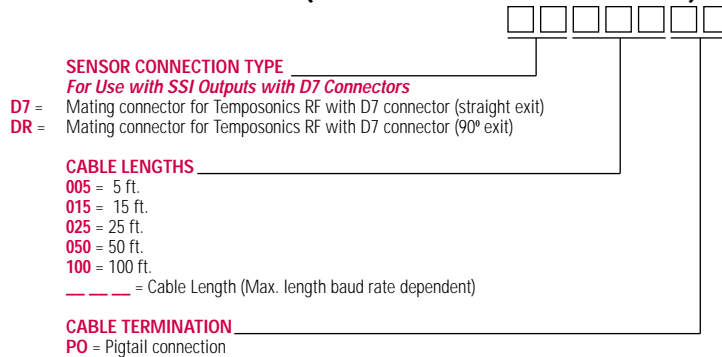

ACCESSORIES

ACCESSORIES

MISCELLANEOUS

Description	Part No.	Notes
Hex Jam-nut (w/ 3/4-16 UNF threads)	500015	For use with Temposonics LF & RF sensors
Hex Jam-nut (w/ M18x 1.5 threads)	500018	For use with Temposonics LF & RF sensors
Magnet Mounting Screws	560357	Used to mount standard ring magnet P/N 201542 (4 screws required) and 90° cutout magnet 201552 (2 screws required)

CONNECTORS

Description	Part No.	Notes
D5 Field-installable Connector	370375	Female, straight exit, for Temposonics RF sensors with DeviceNet output
D5 Field-installable Connector	370376	Female, 90° exit, for Temposonics RF sensors with DeviceNet output
D6 Field-installable Connector	560700	Female, straight exit, mates to D60 connection type on Temposonics RF and LF
D6 Field-installable Connector	560778	Female, 90° exit, mates to D60 connection type on LF and RF Series sensors
D7 Field-installable Connector	560701	Female, straight exit, mates to D70 connection type on Temposonics RF sensors with SSI
D7 Field-installable Connector	560779	Female, 90° exit, mates to D70 connection type on Temposonics RF sensors with SSI
Profibus D6 Field-installable Connector	370427	Male, for Profibus sensors (D63 connection type)
Profibus D6 Field-installable Connector	370423	Female, for Profibus sensors (D63 connection type)
Profibus Bus Terminator	370419	For use with Temposonics RF

POWER SUPPLIES

Description	Part No.	Notes
Power Supply (24/28 Vdc, 0.5A)	380009	For use with Temposonics RF and LF

CABLES

Description	Part No.	Notes
Cable	530026	For Temposonics LF and RF (RF with analog only)
Cable	530029	For Temposonics III sensors with CANbus or SSI output



SENSORS
GROUP

Pioneers,
Innovators,
Leaders in
Magnetostrictive
Sensing

UNITED STATES
MTS Systems Corporation
Sensors Division
3001 Sheldon Drive
Cary, NC 27513
Tel: 800.633.7609
Fax: 919.677.0200
Email: info@temposonics.com
Web: www.temposonics.com

GERMANY
MTS Systems Corporation
Sensors Technologie
Auf dem Schuffel 9, D-58513 Lüdenscheid, Germany
Postfach 8130 D-58489 Lüdenscheid, Germany
Tel: + 49.2351.95870
Fax: + 49.2351.56491
Web: www.mtssensor.de

JAPAN
MTS Systems Corporation
Sensors Technologie, Japan
Ushikubo Bldg.
737 Aihara-cho, Machida-shi
Tokyo 194-0211, Japan
Phone: + 81 (42) 775.3838
Fax: + 81 (42) 775.5512

